

DESIGN 799 – 9 PANELS (IDEAL FOR BILLBOARD-STYLE DESIGNS)

CYAN MAGENTA YELLOW BLACK DIECUT

Please note:

As a guarantee of quality for you and your customers, the Magic Concepts logo will be printed on all Magic Concepts models, in any position in the colors: white, black or gray.

Dimensions: 2.4 x 15 mm
Recommended position: panel 6

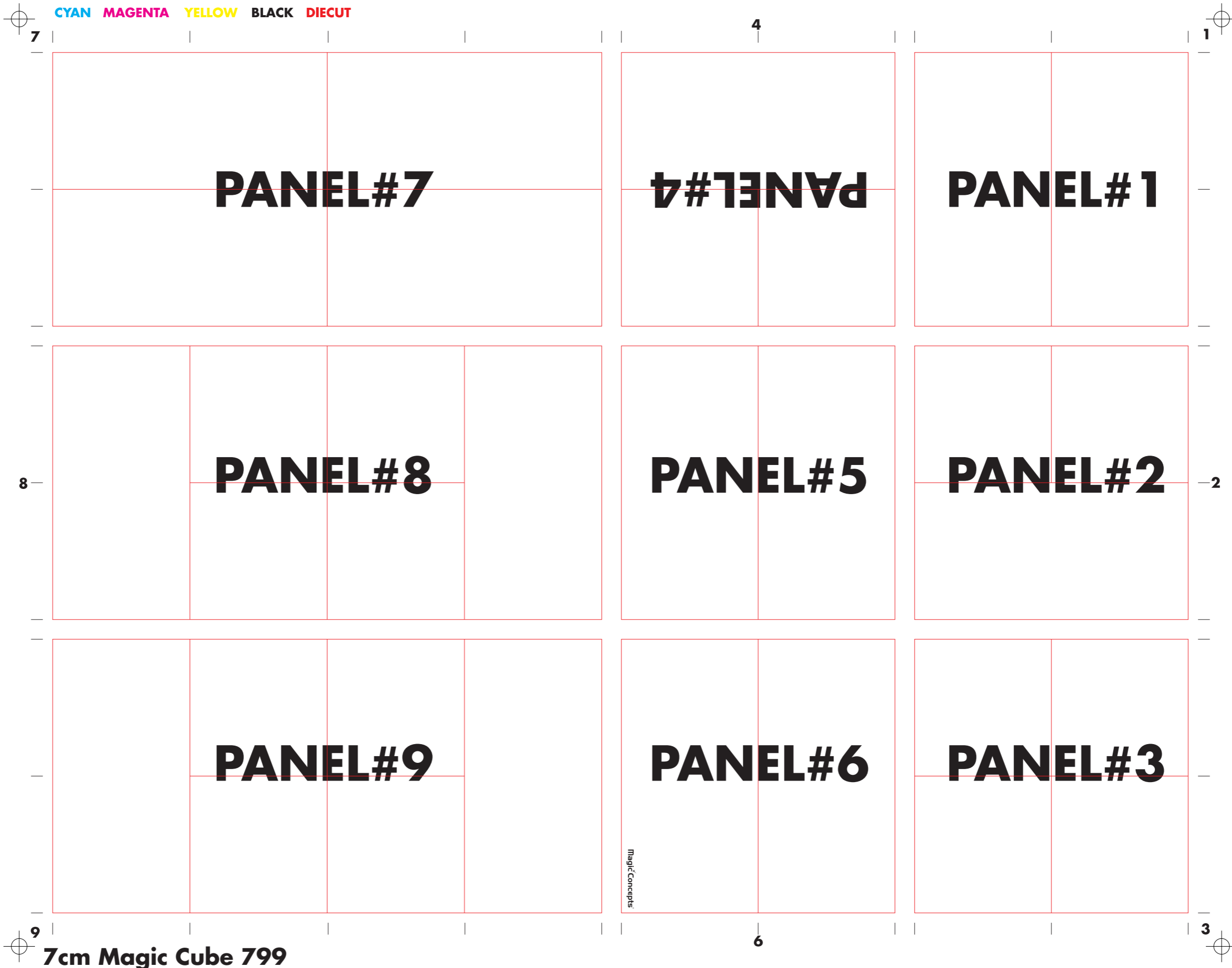

XXXXXXXXXXXXXXXXXXXXXXXXXXXXXXXXXXXX



Magic Cube 799 Panel 1 - 9

START FROM PANEL 1

DESIGN 799 – 9 PANELS
(IDEAL FOR BILLBOARD-STYLE DESIGNS)

STEP 1

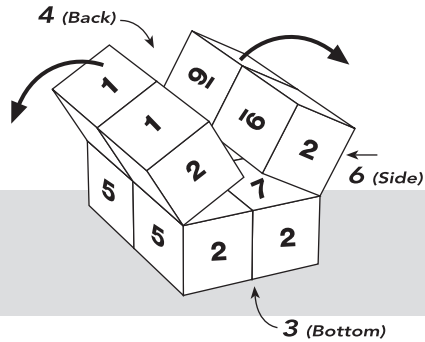

STEP 2 • Open wide Panel 1 to get Panel 7

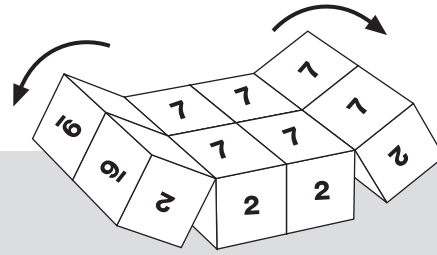

STEP 3 • Open wide Panel 3

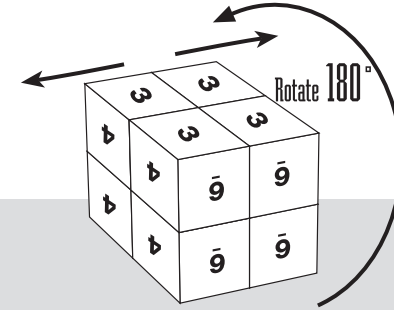

STEP 4 • Ignore this Panel 8

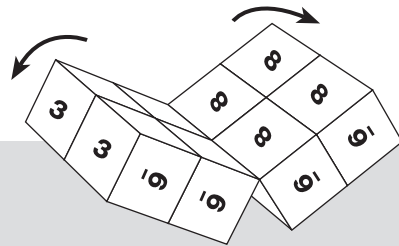

STEP 5 • Open horizontally Panel 8 to Panel 9

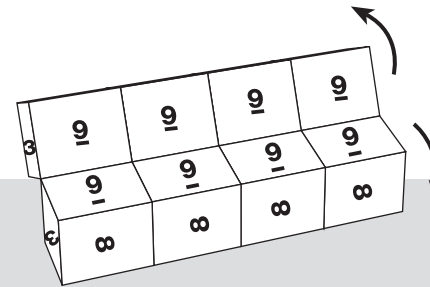

6 Exterior Faces of Magic Cube

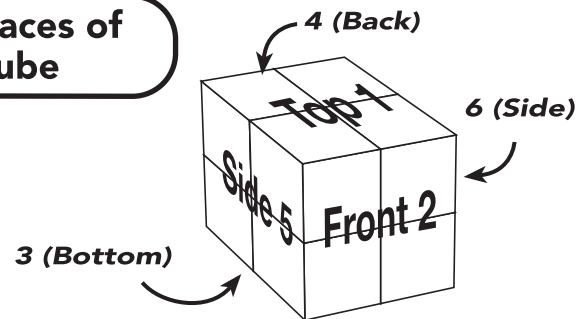

The Manipulation of

Magic
CUBE

Magic Cube 012 (Special)

START FROM PANEL 1

DESIGN 012 – 12 PANELS
(IDEAL FOR CALENDAR-BASED DESIGNS)



Magic Concepts®
AMAZING MEDIA

STEP 1 6 Exterior

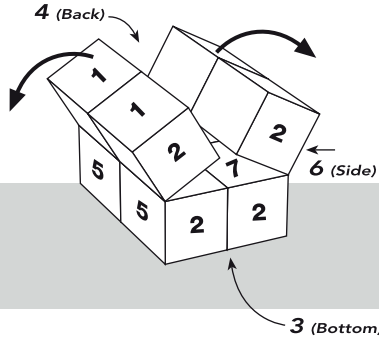

STEP 2 • Open wide Panel 1

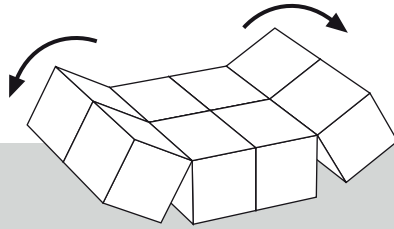

STEP 3 • Open horizontally

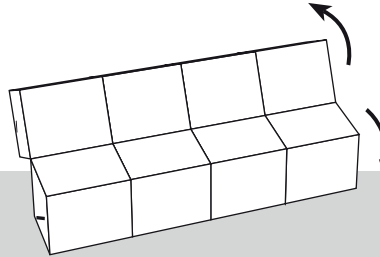

STEP 4 • Open Vertically & Rotate 90°

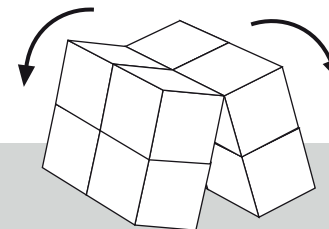

STEP 5 6 Interior

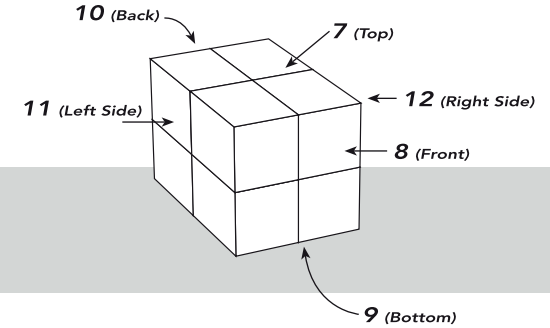

6 Exterior Faces of Magic Cube

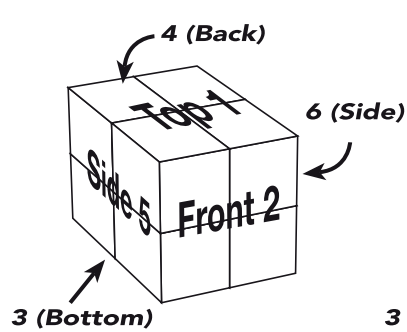

6 Interior Faces of Magic Cube

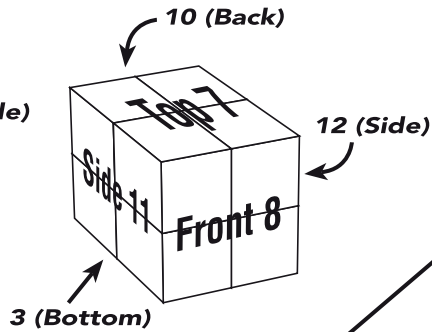

Magic Cube 012

PANEL 10	PANEL 10	PANEL 7	PANEL 7	PANEL 4	PANEL 4	PANEL 1	PANEL 1
PANEL 10	PANEL 10	PANEL 7	PANEL 7	PANEL 4	PANEL 4	PANEL 1	PANEL 1
PANEL 11	PANEL 11	PANEL 8	PANEL 8	PANEL 5	PANEL 5	PANEL 2	PANEL 2
PANEL 11	PANEL 11	PANEL 8	PANEL 8	PANEL 5	PANEL 5	PANEL 2	PANEL 2
PANEL 12	PANEL 12	PANEL 9	PANEL 9	PANEL 6	PANEL 6	PANEL 3	PANEL 3
PANEL 12	PANEL 12	PANEL 9	PANEL 9	PANEL 6	PANEL 6	PANEL 3	PANEL 3

The Manipulation of

Magic
CUBE®

